

STANDARD SIZE (mm)	330	430	530	630	730	830	930	1030	1130	1230	1330
max Z (mm)	70	130	200	200	200	200	200	200	200	200	200

TOOLS REQUIRED

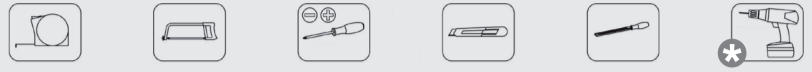

LEFT PULLING

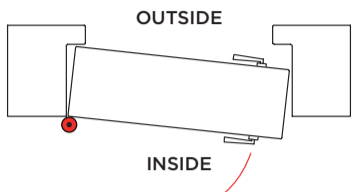

1

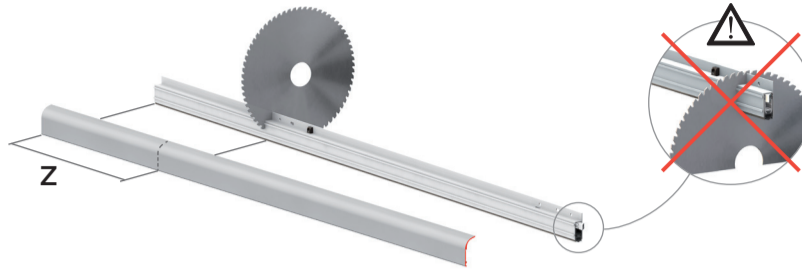

A

COMAX art. 1450 = X - 9mm.

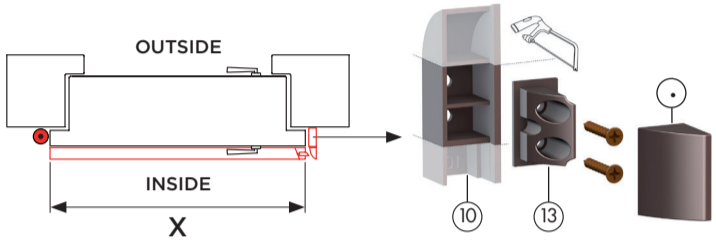

B

COMAX art. 1450 = X - 9mm.

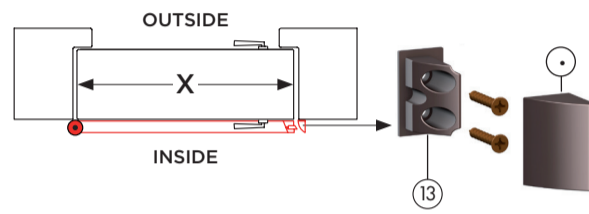

INSIDE APPLICATION

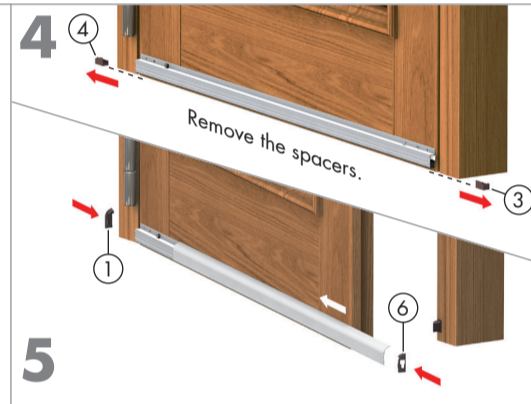
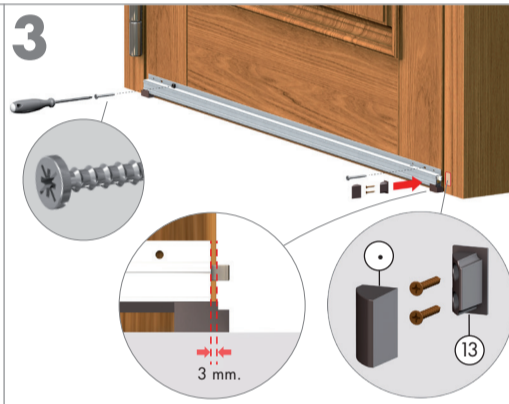
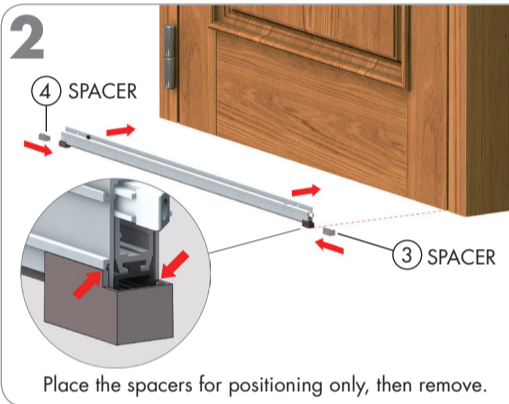
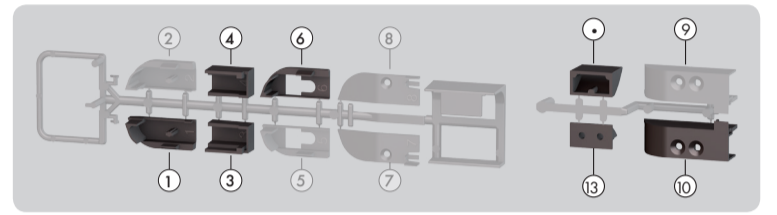

C

COMAX art. 1450 = Y - 16mm.

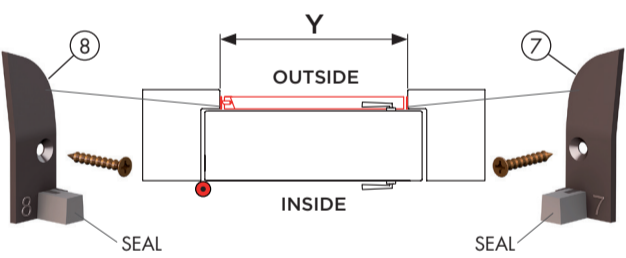

D

COMAX art. 1450 = Y - 16mm. *

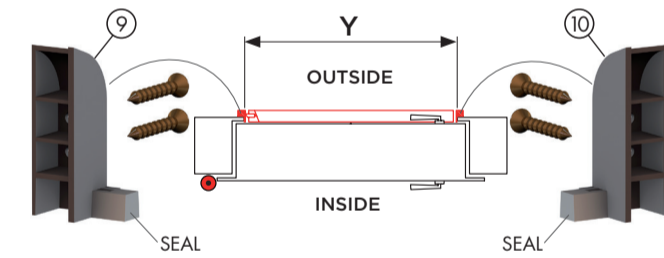

OUTSIDE APPLICATION

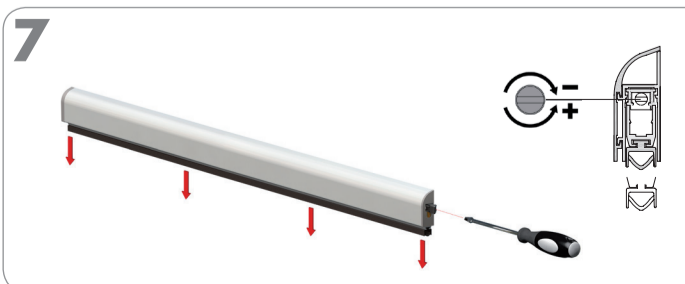
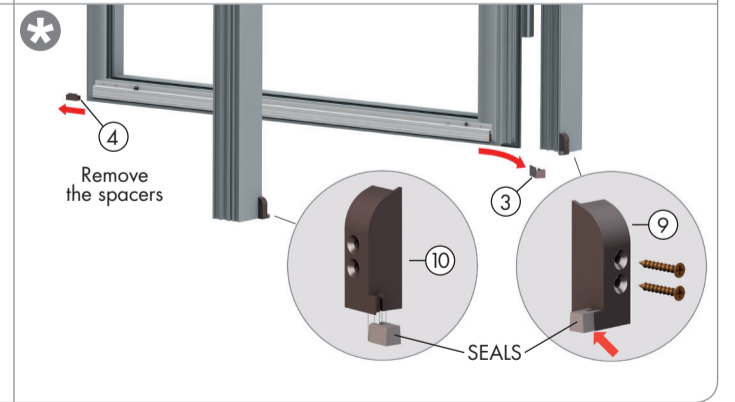
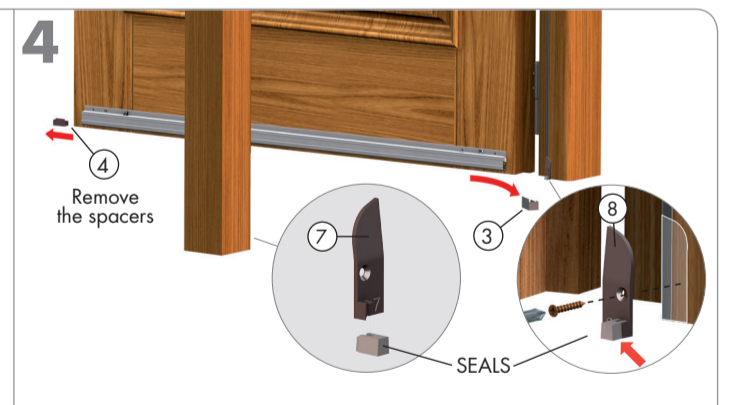
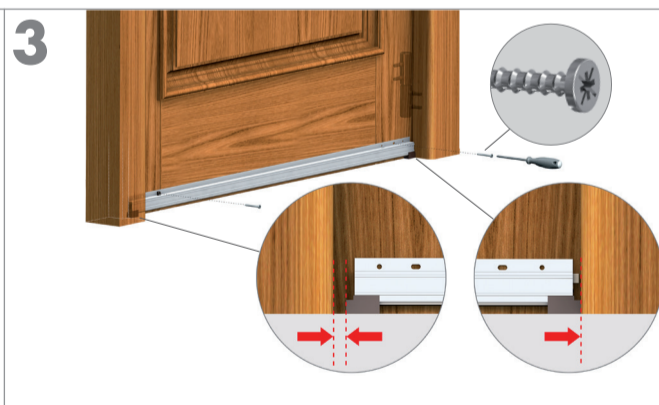
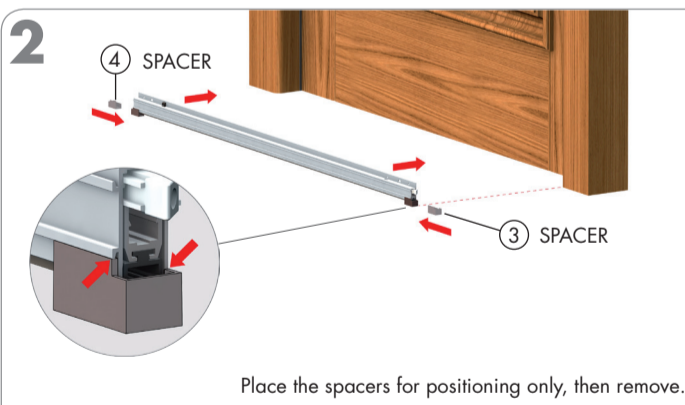
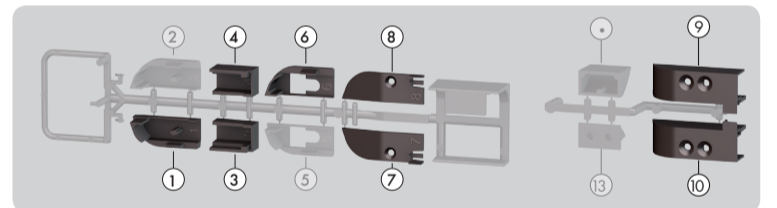

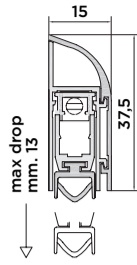

STANDARD SIZE (mm)	330	430	530	630	730	830	930	1030	1130	1230	1330
max Z (mm)	70	130	200	200	200	200	200	200	200	200	200

TOOLS REQUIRED

